

LNBS AND MULTISWITCHES

Solutions for the distribution of the Satellite signal with SCD2 technology (dCSS and dSCR). Single-family and condominium residential systems

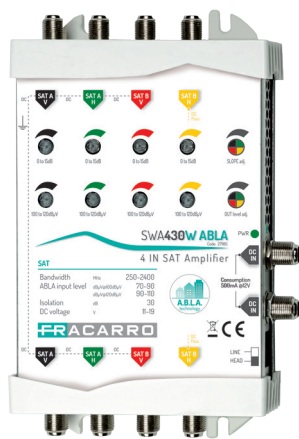

SCD2 LNB with 1 output

287421 - SCD2-16LNB



This LNB is ideal to carry out **single-family residential systems** because has an **SCD2 (dCSS) output** capable of serving up to 4 SCR SAT decoders and simultaneously offering the 12 frequencies necessary for the operation of the new one SKY-Q decoder or other SCD2 dCSS receivers; all through just a single cable.

It has a built-in **LTE signal blocking filter** to avoid interference with the signals used for mobile telephony: the LNB is therefore immune to any disturbances caused to LTE transmissions in the satellite band.

The LNB starts up in static IF-IF mode; in this way the pointing can be carried out with any of the frequencies identified by the instrument; the LNB switches then in dynamic SCD2 dSCR standard after the first command from the decoder is received. Turned off and on again, it restarts in static IF-IF mode.



Cascadable SCD2 multiswitch with 4 inputs

SCD2-4..16LTP Series



Multiswitch SCD2 (dCSS) **in cascade** equipped with **4 satellite inputs** and available in the following versions:

271175 **SCD2-4216LTP**: 4 inputs and **2 outputs** Legacy, SCR or SCD2

271176 **SCD2-4416LTP**: 4 inputs and **4 outputs** Legacy, SCR or SCD2



- Automatic Gain Control (**CAG**): keeps the output level constant even when the signal strength at the satellite inputs varies.
- **Very low loss of passage**, ideal for installing multiple multiswitches in cascade or for insert them into an existing distribution.
- **Autodetection** of the operating mode, according to the STB connected to the port; this allows you to switch from a Legacy STB to an SCR or SCD2 (dSCR) without doing anything intervention on the plant.
- The product can be **powered entirely by decoders**; the power supply is optional for power the multiswitch on the VL line when the decoder cannot support the load of the tap (see compatible power supplies in the **10-19V** range on page 14).
- The **power supply** can be provided both **from the roof and from the ground floor**.

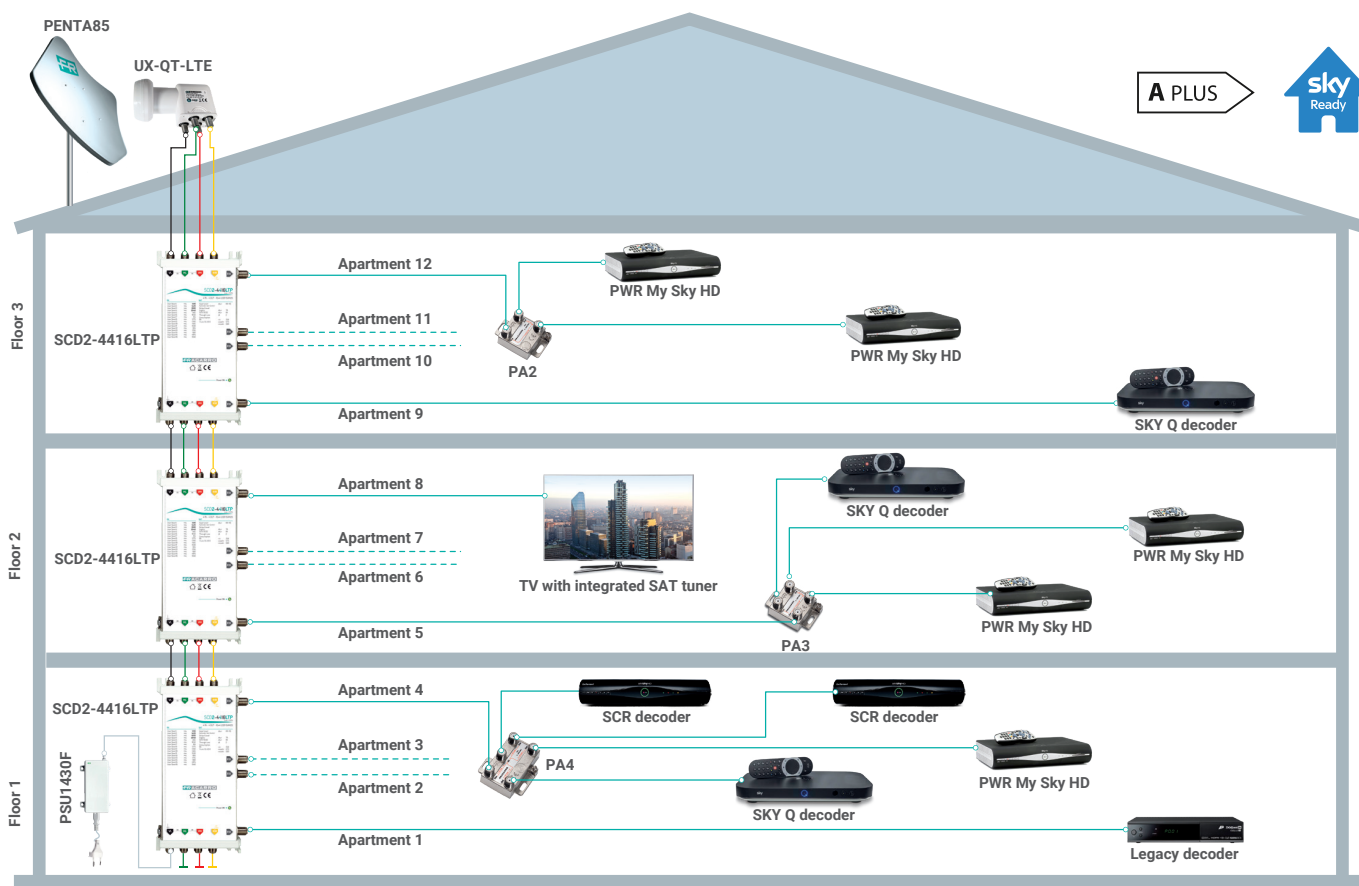

Wideband technology

With WIDEBAND technology, the LNB **supplies the entire horizontal and vertical polarities on the two outputs**, occupying the band from 290 to 2340MHz and leaving the task to the multiswitch to divide each of them into the two low and high portions. As in QUATTRO technology, the multiswitch then sends only the requested band (VL, HL, VH or HH) or the single transponder to the receiver depending on the received DiSEqC command.

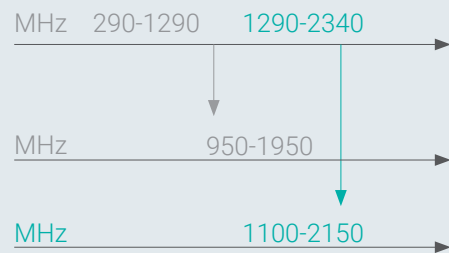
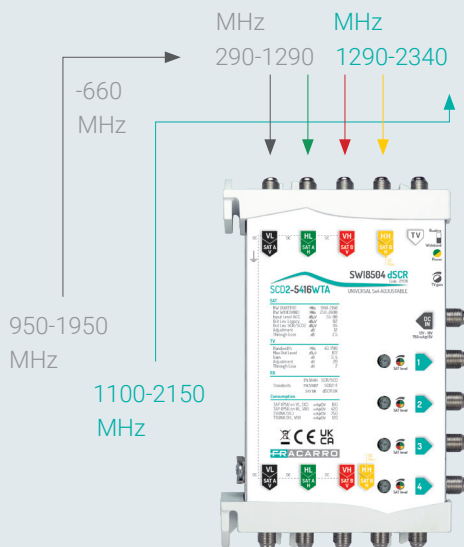

COMPARING THE TWO TECHNOLOGIES

Number of cables: with WIDEBAND technology, the number of coaxial cables connecting the LNB to the multiswitch is half (2 instead of 4): installation is therefore faster and easier, even in the case of **small spaces**. Using existing cables, WIDEBAND technology allows you to convert a traditional QUATTRO single satellite system to WIDEBAND double satellite: in fact, both Hotbird 13°E and Astra 19.2°E can be received and distributed with just 4 cables coming down from the roof.

Choice of products: the bands occupied by the signals outgoing from the LNB going towards the multiswitches are different in the two technologies and can also vary on different WIDEBAND LNB models; for this reason, if a WIDEBAND type LNB with a local oscillator at 10.410 MHz is used (the most common on the market), the **multiswitch connected to it** must also be **WIDEBAND compatible** and set to the same frequency as the oscillator.

Decoders and distribution are the same in the two technologies because the satellite signal outgoing from the QUATTRO or WIDEBAND multiswitch, which serves the user socket, always occupies the 950 to 2150 MHz band; **cables, splitters and receivers** (be they legacy, SCR or SCD2 dCSS) are in any case **compatible with both technologies**. In WIDEBAND systems, when there is a signal division along the drop (between LNB and multiswitch) it is necessary to use products with **band up to 2340MHz**.

QUATTRO

WIDEBAND

LNB	Receives full horizontal and vertical polarities from dish Divides each into low, from 10.7 to 11.7GHz and high, from 11.7 to 12.75GHz Converts them over 4 coaxial cables in the frequencies from 950 to 2150MHz	Receives full horizontal and vertical polarities from dish Converts them over 2 coaxial cables in the frequencies from 290 to 2340MHz
MSW	MSW Receives the VL, HL, VH and HH bands from the LNB It sends only the requested band or the single transponder to the decoder based on the received DiSEqC tone	Receives full vertical and horizontal polarities from the LNB Divides each of them into low, from 950 to 1950MHz and high, from 1100 to 2150MHz It sends only the requested band or the single transponder to the decoder based on the received DiSEqC tone

WIDEBAND LNB with 2 outputs

287541 - UX-WB LTE



UX-WB LTE is the new **UX Wide Band family** LNB converter with **2 outputs**, separate polarities H (horizontal) and V (vertical) and with reduced current consumption (only 100mA).

The Wide Band LNB allows you to **distribute the signal of a satellite using only 2 cables** or, alternatively, the signal from two different satellite positions using only 4 cables. It therefore replaces a QUATTRO LNB (e.g. UX-QT LTE) guaranteeing the same content using half the cables; no receivers or special sockets are needed, distribution and decoders are the traditional ones (FTA, SKY-Q,...).

Multiswitches compatible with this technology also allow you to receive a input TV signal and mix it into the output ports.

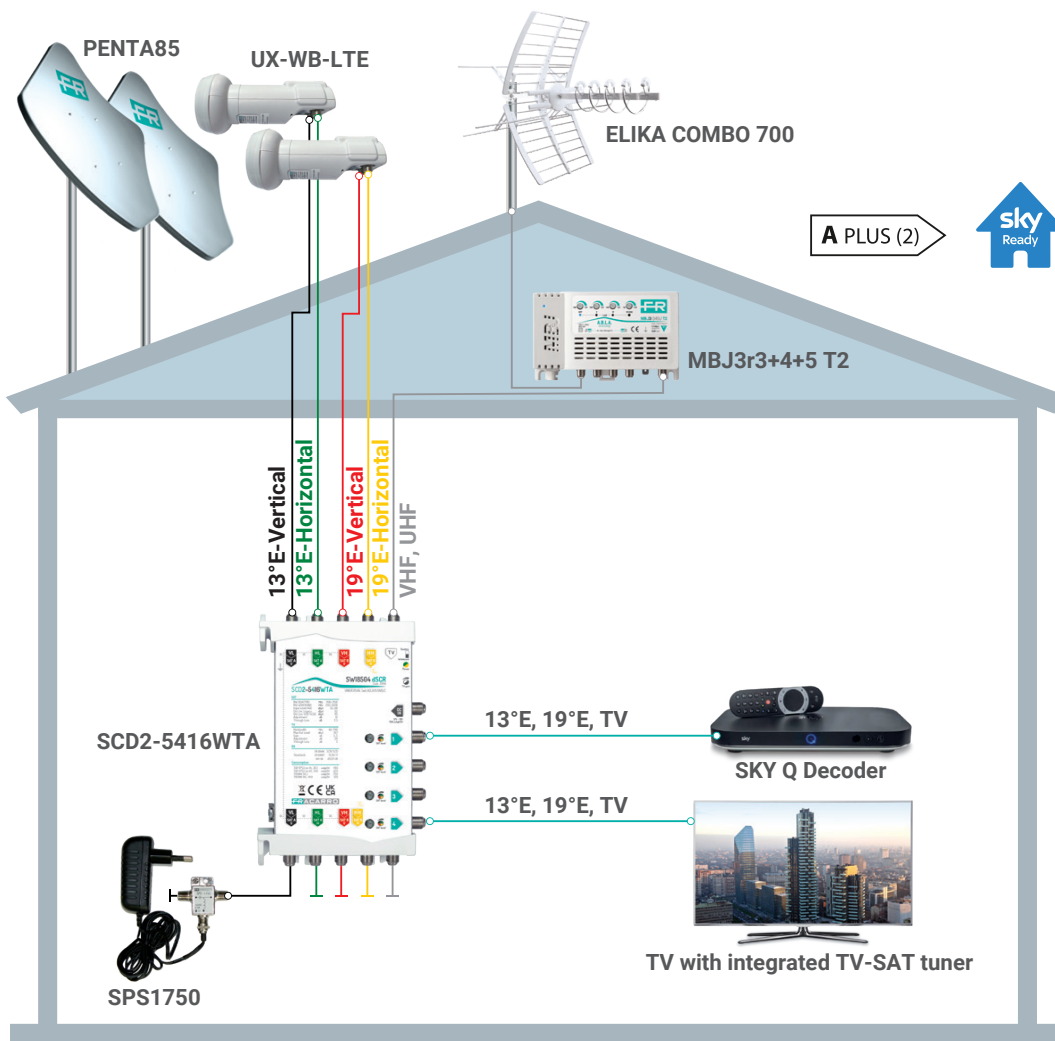

Cascadable SCD2/dSCR multiswitch with 5 input

SCD2-5..16W Series

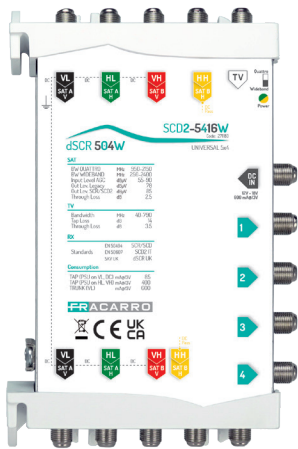

Multiswitch SCD2 (dCSS) in cascade equipped with 5 SAT+TV inputs, with FVM technology and available in the following versions:

- 271184 **SCD2-5216W**: 5 inputs and **2 outputs** Legacy, SCR or SCD2/dSCR
- 271180 **SCD2-5416W**: 5 inputs and **4 outputs** Legacy, SCR or SCD2/dSCR
- 271183 **SCD2-5616W**: 5 inputs and **6 outputs** Legacy, SCR or SCD2/dSCR
- 271179 **SCD2-5816W**: 5 inputs and **8 outputs** Legacy, SCR or SCD2/dSCR

- **Compatible** both with **traditional LNB** (287302 - UX-QT LTE) and with **Wideband** type LNB with L.O. 10.410MHz (287541 - UX-WB LTE).
- **Automatic Gain Control (AGC)**: keeps the output level constant even when the signal strength on the satellite inputs varies.
- **Low insertion loss**, ideal for installing multiple multiswitches in cascade or for inserting them into an existing distribution.
- **Autodetection** of the operating mode according to the connected STB.
- The product can be **powered entirely by decoders**; the power supply is optional to power the multiswitch on the VL line when the decoder is unable to support the load of the tap (see compatible power supplies in the **12-18V** range at page 14).
- The **power supply** can be provided **both from the roof and from the ground floor**.
- **Universal standard**: compatible with both the **SCR/SCD** and **SCD2** frequencies used by SKY and Tivùsat in Italy, and with the English **dSCR UK standard**.

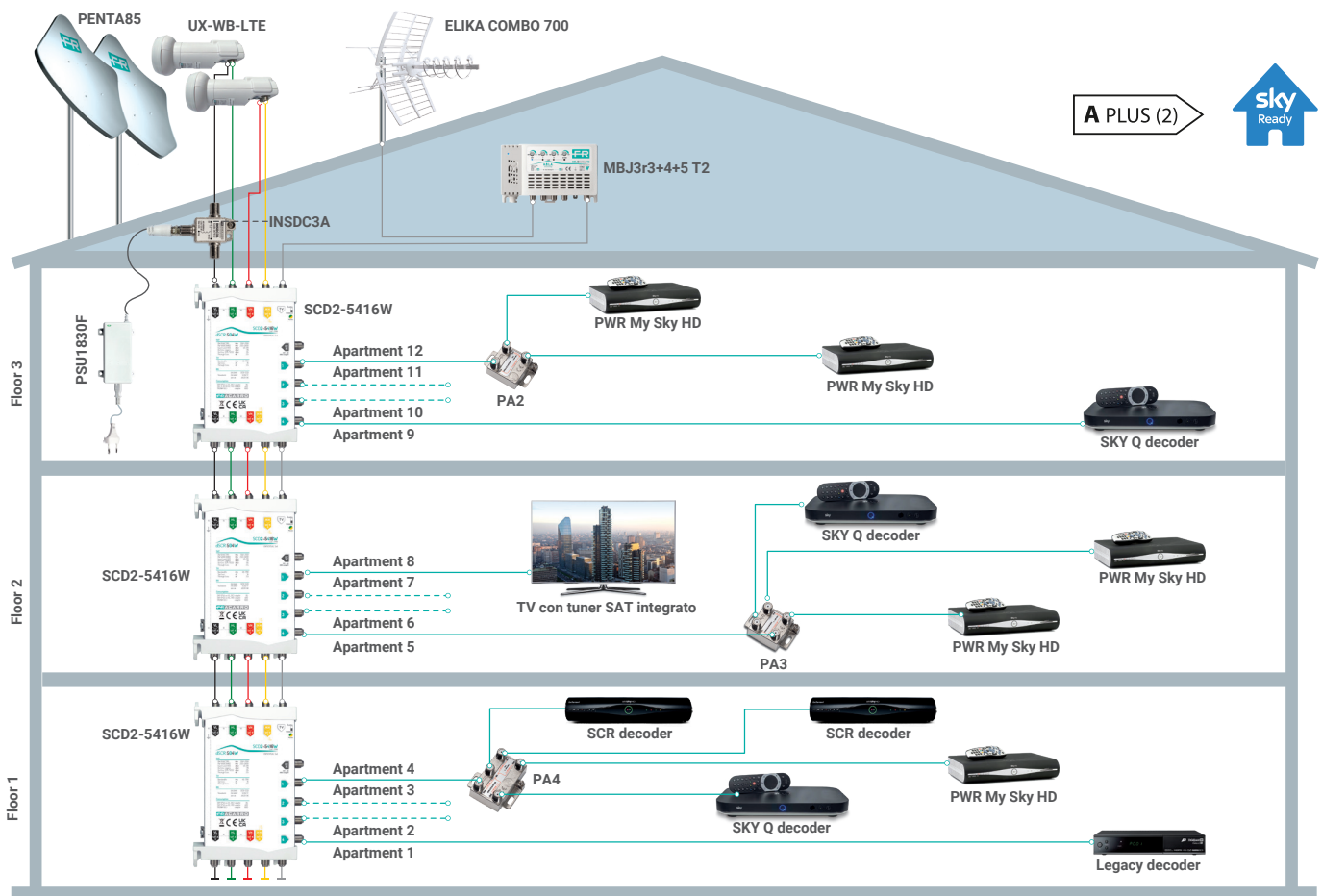

Cascadable SCD2/dSCR multiswitch with 5 adjustable active inputs

SWI85 dSCR Series

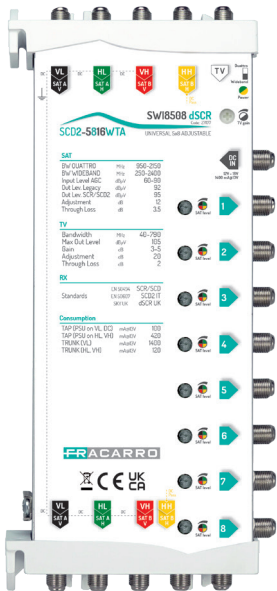

Multiswitch SCD2 (dCSS) **in cascade** equipped with **5 active and adjustable SAT+TV inputs**, with **FVM technology** and available in the following versions:

271178 **SWI8504 dSCR**: 5 adjustable active inputs and **4 Legacy**, SCR or SCD2 outputs

271177 **SWI8508 dSCR**: 5 adjustable active inputs and **8 Legacy**, SCR or SCD2 outputs

- Compatible both with **traditional LNB** (287302 - UX-QT LTE) and with **Wideband** type LNB with L.O. 10.410MHz (287541 - UX-WB LTE).
- Active and adjustable TV input for mixing DTT and Satellite signals in distribution.
- **High SAT level** and separate regulation for each output
- Automatic Gain Control (**AGC**): maintains the set output level even when the signal strength varies in the satellite inputs.
- **Autodetection** of the operating mode according to the connected STB.
- **The external power supply is required to power the TV and Satellite active parts**; by inserting the voltage on the VL line, the power supply also takes charge of the output part, to power the multiswitch when the decoder is unable to support the load of the tap (see compatible power supplies in the **12-18V** range on page 14).
- The **power supply** can be provided **both from the roof and from the ground floor**.
- Universal standard: compatible with both the SCR/SCD and SCD2 frequencies used by SKY and Tivùsat in Italy, and with the English **dSCR UK** standard.

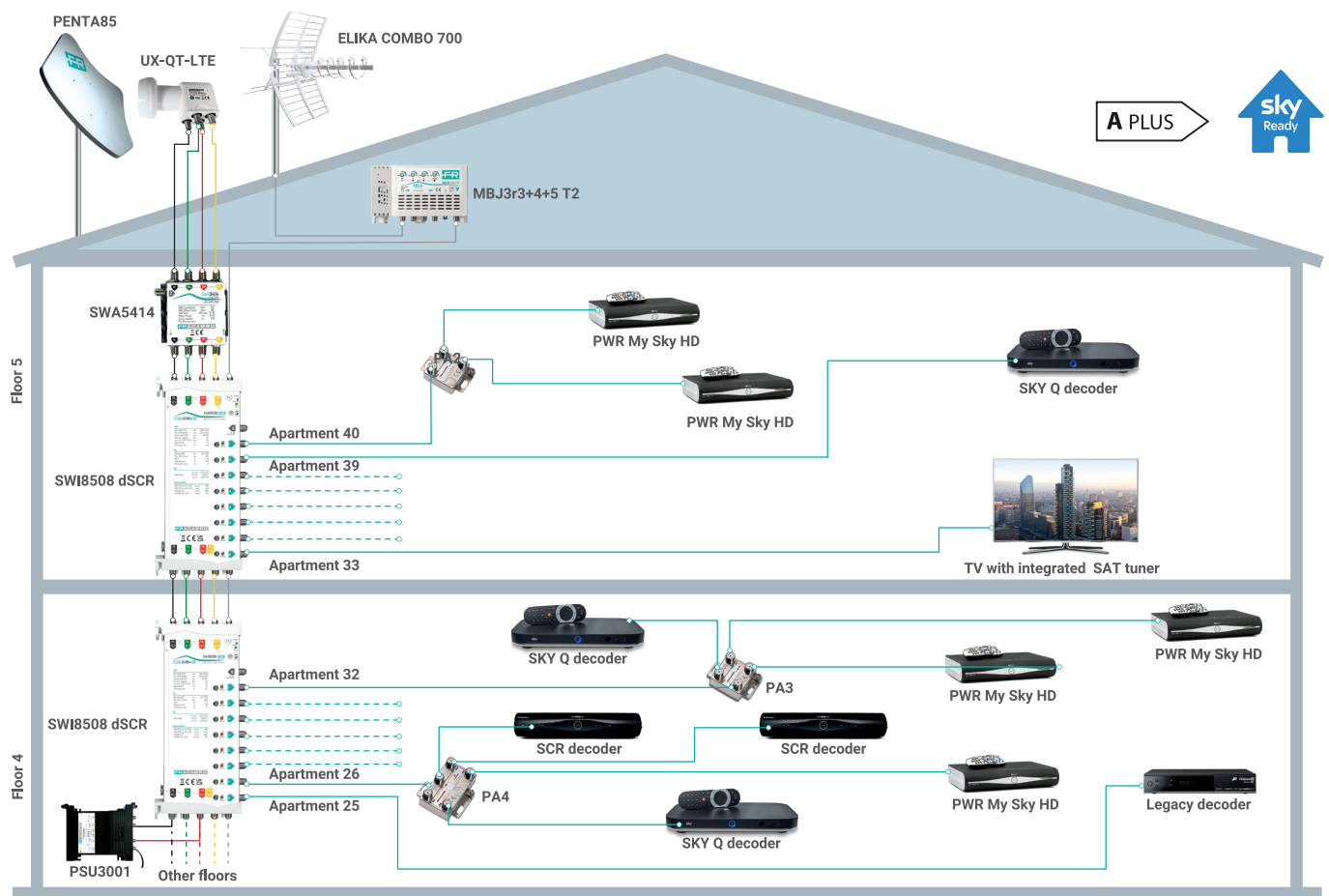

FVM technology

(Flexible Voltage Management)

For the installation of the dCSS system it is advisable to consider that the **current consumption** of this new technology on the user port is about 350mA, much higher than the traditional legacy one (about 50-100mA); to better adapt to system needs, Fracarro has created the innovative **FVM** (Flexible Voltage Management) technology, which provides **different voltage control modes**: the products can in fact be powered by order of priority: from the DC-IN port, from the VL line or from the decoder alone, without having to act on an external dip switch.

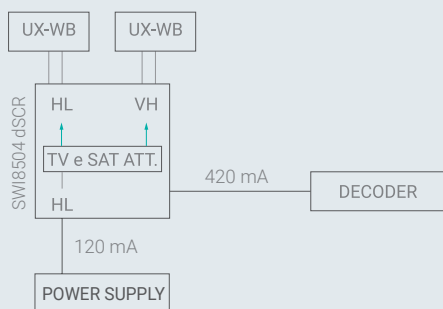
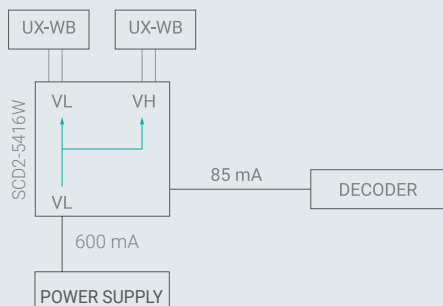
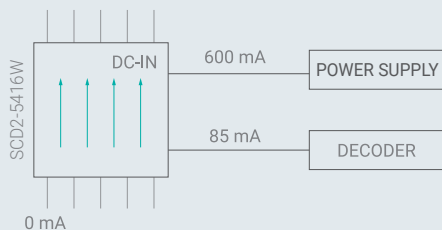

1 Power supply from DC-IN port. The products are equipped with a DC-IN F connector, the voltage present on **this connector takes charge of the whole power supply of the multiswitch** and is automatically **blocked towards the LNB**, in order not to interfere with the existing system; the trunk lines become secondary even if crossed by a higher voltage and the load to the decoder on the user port drops to 85mA. This solution is ideal for inserting a multiswitch in an **existing system**, because it keeps consumption unchanged on the backbone of the building.

2 Power supply from VL line. This type of system is the most common: **multiswitch and LNB are entirely powered by the building backbone** and the consumption of the decoder on the user port drops to 85mA. The VH and HL lines can be used to distribute the load on more complex systems and the voltage on the VL line is also sent to the VH input to be able **to power two different LNBs with a single power supply** (e.g. WIDEBAND system with 2 satellites on 4 cables, see page 5).

3 Power supply from decoder only: this mode is activated when there is no voltage on the DC-IN connector or on the VL line and is useful for **limiting the load of the multiswitch on the backbone** or when there is no possibility to carry any voltage on the floor; in this case:

- the voltage from the decoder is **blocked towards the LNB** in order not to bring too much load to the user port
- the voltage on the HL line is also sent to the VH input to be able **to power two different LNBs with a single power supply**.
- With this type of power supply:
- **SCD2-5..W Series:** the entire multiswitch is powered by the decoder, just install a power supply on the HL or VH for the LNB
- **SWI85 dSCR Series:** only the TV and Satellite input amplifiers are powered by the HL or VH lines, the SCD2 output part is powered by the decoder to minimize the load on the system backbone and avoid installation errors.

Thanks to this technology, it is possible **to solve all the remote feeding problems** present on the systems, because the products can be powered with an external power supply (in the 12-18V range, see page 14) to **reduce the current load** on the taps and guarantee their operation with any type of decoder, even in systems with long stretches of coaxial cables; the DC passage on all the ports and the direct line on HH guarantee the continuity of the remote feeding and compatibility with the multiswitches already installed.

Reception in areas with **weak** or **absent digital terrestrial signal**

In areas with **poor digital terrestrial signal reception**, such as coastal areas where the phenomenon of sea refraction can compromise the quality of the signals and in cases where not even an active antenna with high performance and quality distribution can guarantee a stable signal, Fracarro offers solutions that use the **satellite signal for the reception of contents present on Digital Terrestrial**.

In residential structures, with the use of a satellite dish and **IF-IF SCD2 headends**, it is possible to receive many national

and international channels in HD and 4K in a stable and high-quality manner, including the SKY offer.

With this solution it is possible **to add the signal coming from one or more satellites to the existing TV distribution**; it is very convenient for updating existing systems, even the oldest ones, in a very easy and cheap way.

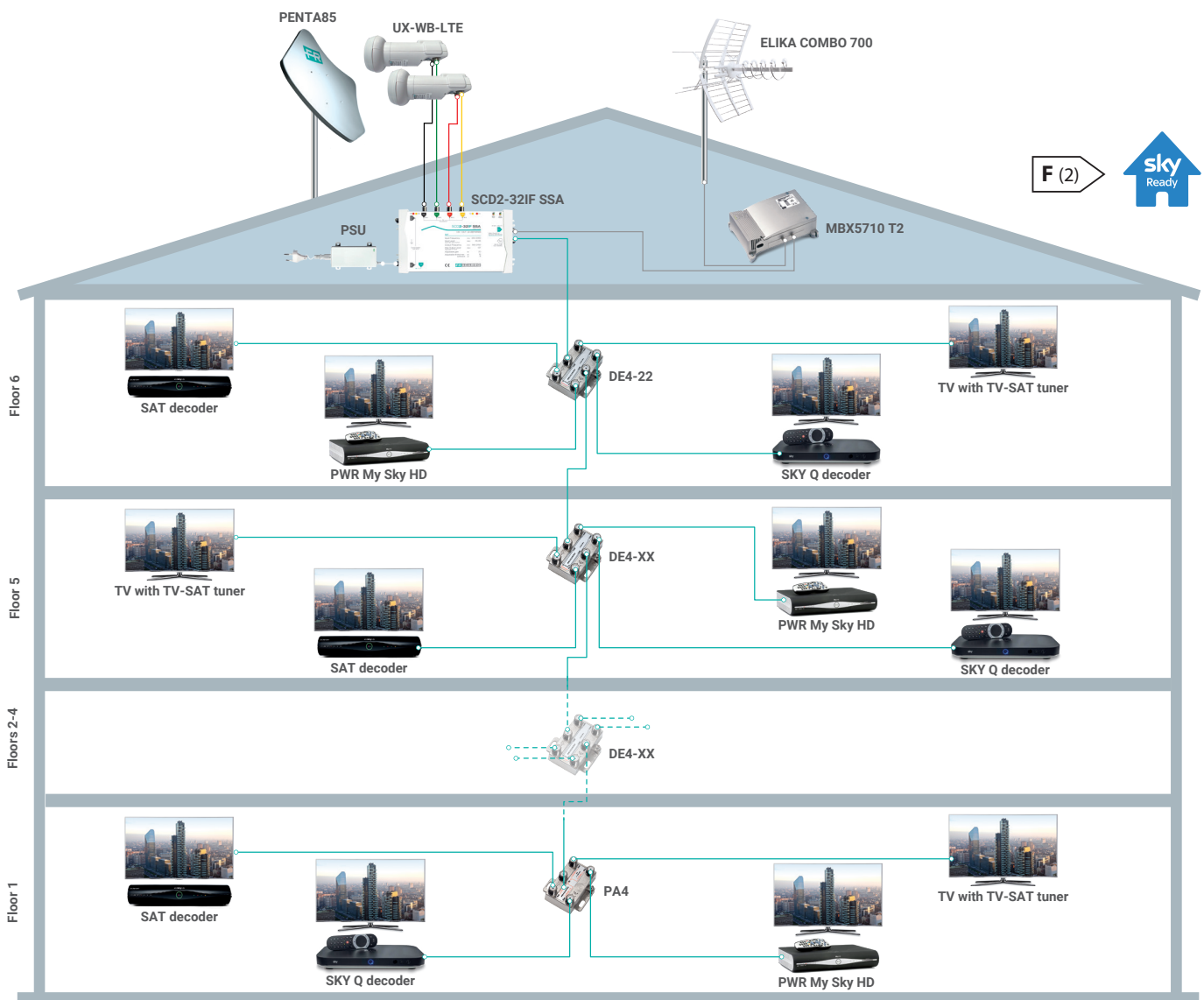

IF-IF SCD2 compact headends with 4 inputs

SCD2-32IF Series

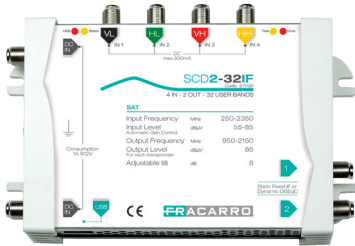

Compact IF-IF headends, ideal for inserting the Satellite signal into an existing system with no need to modify the existing distribution.

- SCD2 (dCSS) technology with **4 satellite inputs** to convert up to 32 DVB-S/S2 transponders;
- **Compatible** both with **traditional LNB** (287302 - UX-QT LTE) and with Wideband type LNB with L.O. 10.410MHz (287541 - UX-WB LTE).
- Power supply included and remote feeding towards the LNB.

271130 - SCD2-32IF

Compact IF-IF headend with **2 outputs** and 86dB μ V output level for each transponder, to serve sockets that are **up to 90 metres** away from the main headend; ideal for **small or medium sized systems**.



271138 - SCD2-32IF SSA

Compact IF-IF headend with **1 passive TV input** and 1 mixed output and total Satellite output level of 128dB μ V, to serve sockets that are **up to 150 metres** away from the main headend; ideal for **medium or large systems**. This headend allows gain (20dB) and slope (15dB) adjustments in the Satellite band.

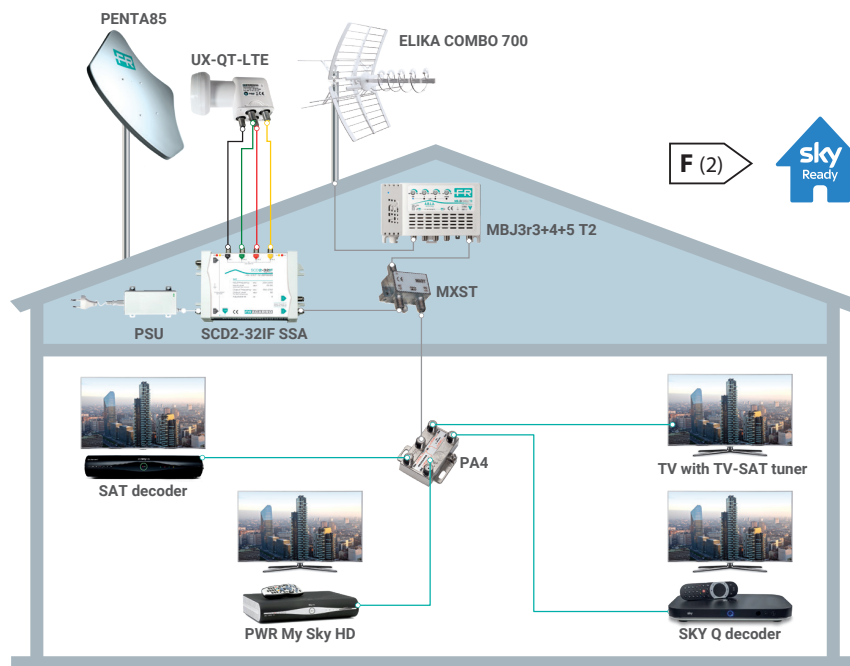

A.B.L.A. head and line amplifiers with 4 satellite input

435 ABLA Series

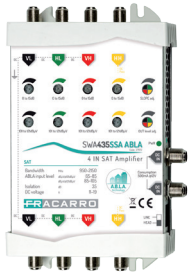

Line and head amplifiers with built-in power supply and with **4 Satellite inputs** and **A.B.L.A. technology** (Automatic Building Level Adjustment), which keeps constant the set output level even when the strength of the input signal varies. They are available in the following versions:

271173 **AMP435SA**: head amplifier with 4 A.B.L.A. inputs, adjustable 35dB gain and power supply included;

271171 **AMP435SSA**: head amplifier with 4 A.B.L.A. inputs, adjustable 35dB gain, slope adjustment and power supply included;

271172 **SWA435SSA**: line amplifier with 4 A.B.L.A. inputs, adjustable 35dB gain and slope adjustment.

271185 **SWA430W**: line amplifier with 4 Wideband inputs, A.B.L.A. technology, adjustable 30dB gain and slope adjustment.

Thanks to their high Satellite output level (121dB μ V) and the excellent separation between the inputs (35dB), are ideal for **medium and large installations** or wherever there are long distances between the multiswitches and the LNB; these amplifiers are also easy to install thanks to the new trimmers and the standard colours of the inputs.

The 435 ABLA series offers a high robustness of the system also thanks to the **double power supply port** and the **protection against current overloads** on the DC-IN F connectors.

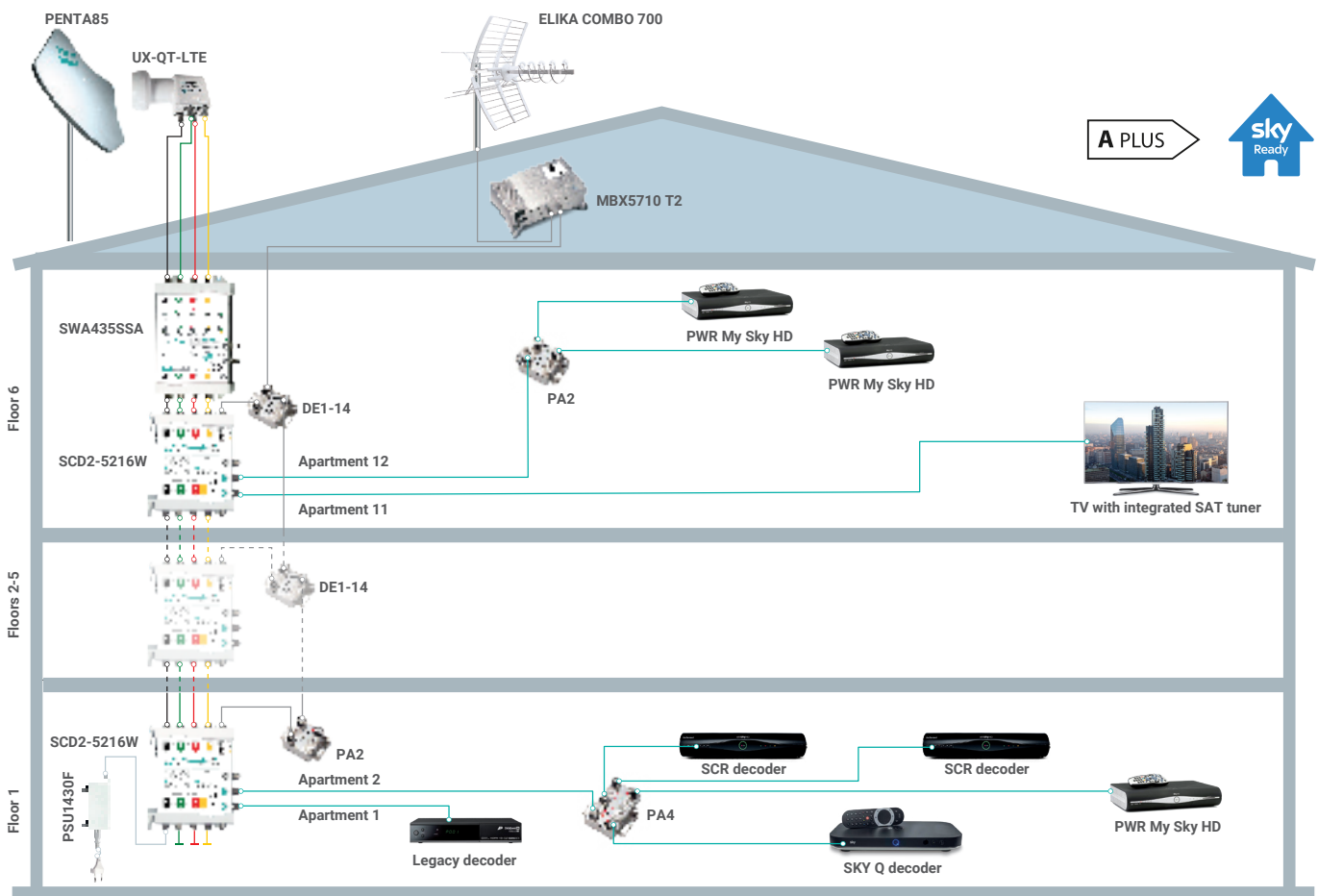

A.B.L.A. Technology

(Automatic Building Level Adjustment)

The AMP435SA, AMP435SSA, SWA435SSA and SWA430W amplifiers feature the A.B.L.A. (Automatic Building Level Adjustment) technology; thanks to that it is possible **to set the desired output level** and the product is able to keep this level even when the power of the received signal varies.

At each input there is an **A.B.L.A. LED**, which can be used to monitor signal strength

- **LEDs on:** the level of the **input signal** is within the **expected range** and the automatic adjustment of output signal is working properly;
- **LEDs off:** the input level does not meet the requirements to keep the output signal constant, in this condition the product behaves like a **normal Satellite amplifier with 36dB** of gain and 20dB of regulation (30dB of gain in the SWA430W model).

The dynamics of the input signal varies according to the set output level, to calculate it, it is sufficient to apply the following formula:

minimum INPUT power = set OUTPUT power - 36dB (-30dB for the SWA430W model)

maximum INPUT power = set OUTPUT power - 16dB (-10dB for the SWA430W model)

HEAD and LINE modes

The big news of the **435ABLA Series** is the **flexibility** with which it is possible to use AMP and SWA both as head amplifiers and as line amplifiers; thanks to the dip switch located on the side of the mechanics, it is possible to set different voltage management modes.

Power supply from DC-IN port: this is the typical case of **head amplifier**, the product is entirely powered by the DC-IN port, it protects the power supply from overloads and supplies the remote feeding to the input ports to feed the **LNB**.

HEAD mode:

the **remote feeding is interrupted downwards**, in order not to interfere with the voltages of the downstream system, no need to install DC BLOCKS.

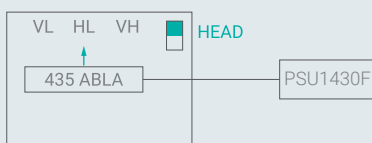

Power supply from VL, HL or VH Satellite trunk lines: this is the typical case of a **line amplifier**, the product is entirely powered by the Satellite lines and **passes the voltage** towards the input ports, to power the LNB, without any current limitation in order not to interfere with the existing system; in this configuration the dip switch must be positioned in **LINE mode**.



LINE mode: there is a passage of voltage also downwards

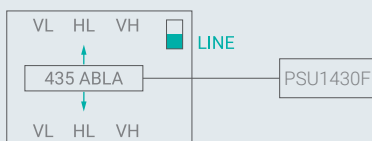

In all models of the series there is no power draw from the **HH line**: this Satellite port is used **to pass a current directly**, without any absorption by the amplifier, for example to power the LNB using a dedicated power supply at the base of the system.

POWER SUPPLIES WITH F CONNECTOR



Code	287155	289087	287614	287647*	287612	271160	271159*
Item	PSU1506	SPS1750	PSU1430F	PSU1430F/UK	INSDC3A	PSU3001	PSU3001/UK
Voltage	15V	15V	14V	14V	-	18V	18V
Current	600mA	1,000mA	3,000mA	3,000mA	Max 3,000mA	2 x 1,500mA	2 x 1,500mA
Insertion loss	-	-1dB	-	-	-0.5dB	-1.5dB	-1.5dB

(*) UK PLUG

SCD2 RANGE

Code	Item	Number of LNBS	Number of Apartments	TV Insertion Loss	SAT output level with CAG	Consumption on VL@13v
287421	SCD2-16LNB	1	1	-	84B μ V	360mA
271175	SCD2-4216LTP	1	2	-	85dB μ V	330mA
271176	SCD2-4416LTP	1	4	-	85dB μ V	600mA
271184	SCD2-5216W	1 o 2 (*)	2	-14dB	85dB μ V	330mA
271180	SCD2-5416W	1 o 2 (*)	4	-14dB	85dB μ V	600mA
271183	SCD2-5616W	1 o 2 (*)	6	-16dB	85dB μ V	900mA
271179	SCD2-5816W	1 o 2 (*)	8	-18dB	85dB μ V	1.250mA
271178	SWI8504 dSCR	1 o 2 (*)	4	from -15 to 5dB	from 83 to 95dB μ V	750mA
271177	SWI8508 dSCR	1 o 2 (*)	8	from -15 to 5dB	from 83 to 95dB μ V	1.400mA
271130	SCD2-32IF	1 o 2 (*)	-	-	from 78 to 86dB μ V	-
271138	SCD2-32IF SSA	1 o 2 (*)	-	-2dB	from 84 to 112dB μ V	-

(*) The single satellite can be received with QUATTRO LNB on 4 cables (287302 - UX-QT LTE) or with WIDEBAND LNB on 2 cables (287541 - UX-WB LTE); double satellite can be received with 2 WIDEBAND LNBS on 4 cables.

Fracarro SCD2 solutions

The following examples have been designed considering an LNB output power of 75dB μ V and 5 m of PAS4007111 coaxial cable between floors; the TV part has not been evaluated because it varies from area to area. The LNBS were also considered in the consumption calculations; in the examples with 2 power supplies the DC-BLOCKS must be inserted to separate their voltages.

SATELLITE SYSTEM		
Single house	1 x SCD2-4216LTP 1 x PSU1506	
NO. APARTMENTS X FLOOR	2	4
1 floor	1 x SCD2-4216LTP 1 x PSU1506	1 x SCD2-4416LTP 1 x SPS1750
2 floors	2 x SCD2-4216LTP 1 x SPS1750	2 x SCD2-4416LTP 1 x PSU1430F
3 floors	3 x SCD2-4216LTP 1 x PSU1430F	3 x SCD2-4416LTP 1 x PSU1430F
4 floors	4 x SCD2-4216LTP 1 x PSU1430F	4 x SCD2-4416LTP 1 x PSU1430F
5 floors	5 x SCD2-4216LTP 1 x PSU1430F	5 x SCD2-4416LTP 1 x PSU3001

TV + SATELLITE SYSTEM (*)				
Single house	1x SCD2-5216W 1x PSU1506			
NO. APARTMENTS X FLOOR	2	4	6	8
1 floor	1x SCD2-5216W 1x PSU1506	1x SCD2-5416W 1x SPS1750	1x SCD2-5616W 1x SPS1750	1x SCD2-5816W 1x PSU1430F
2 floors	2x SCD2-5216W 1x SPS1750	2x SCD2-5416W 1x PSU1430F	2x SCD2-5616W 1x PSU1430F	2x SCD2-5816W 1x PSU1430F
3 floors	3x SCD2-5216W 1x PSU1430F	3x SCD2-5416W 1x PSU1430F	3x SCD2-5616W 1x PSU1430F	3x SCD2-5816W 1x PSU3001
4 floors	1x SWA5414 4x SCD2-5216W 1x PSU1430F	4x SCD2-5416W 1x PSU1430F	1x SWA5414 4x SCD2-5616W 1x PSU3001	1x SWA5414 4x SCD2-5816W 2x PSU1430F
5 floors	1x SWA5414 5x SCD2-5216W 1x PSU1430F	1x SWA5414 5x SCD2-5416W 1x PSU3001	1x SWA5414 5x SCD2-5616W 2x PSU1430F	1x SWA5414 5x SCD2-5816W 2x PSU3001

(*) In the SCD2-5..W Series the same systems can be developed with double satellite, replacing the QUATTRO LNB with 2 WIDEBAND LNBS (287541 - UX-WB LTE). In the examples, the PSU1506 and the SPS1750 can be replaced by the PSU1430F/UK.

Fracarro Radioindustrie SRL

via Cazzaro 3 31033 Castelfranco Veneto (TV) Italia
tel +39 0423 7361 - fax +39 0423 736220 - info@fracarro.com
www.fracarro.com

